

REGISTER YOUR TOTAL OPTIONS DISPLAY

TO BE INCLUDED IN SOMERSET'S WEBSITE DEALER LOCATOR



IMPORTANT: Only dealers who have purchased Somerset's Total Options Display or TOD Update Kit and have **registered their displays** will be eligible to be included in our website Dealer Locator area.

You don't want to miss out on the valuable opportunity to have potential customers directed to your location!

REGISTRATION FORM

(*All information must be filled out. Please print.)

*Contact Name _____ *Date _____

*Dealer Name _____

*Street Address (No P.O. Box) _____

*City _____ *State _____ *Zip _____

*E-mail _____ *Phone _____
 YES, please add me to your email list.

*Name of Your Somerset Distributor _____

Website Address (URL): _____

What is your top selling brand of hardwood flooring today?

Thank you for allowing our display to be in your store. Could you share with us the main reason you placed a Somerset display in your showroom?

SUBMIT REGISTRATION IN ONE OF FOUR WAYS:

1 CALL TOLL-FREE:
877-404-9663

2 FAX FORM TO:
606-678-0283

3 E-MAIL INFORMATION TO:
sales@somersetfloors.com

4 MAIL FORM TO:
Attn: TOD Registration
Somerset Hardwood Flooring
PO Box 1355, Somerset, KY 42502

THIS FORM IS ALSO AVAILABLE AT OUR WEBSITE IN THE RESOURCE CENTER.

Click on the Resource Center button on the home page, then select the "Especially For Dealers" tab in the Resource Center. The form is listed under the Retail Display Program section.

www.somersetfloors.com

Somerset Hardwood Flooring

Sample Tower Instruction Sheet

Directions for Assembly

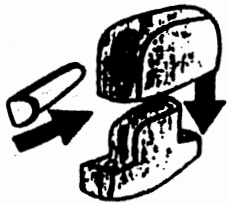
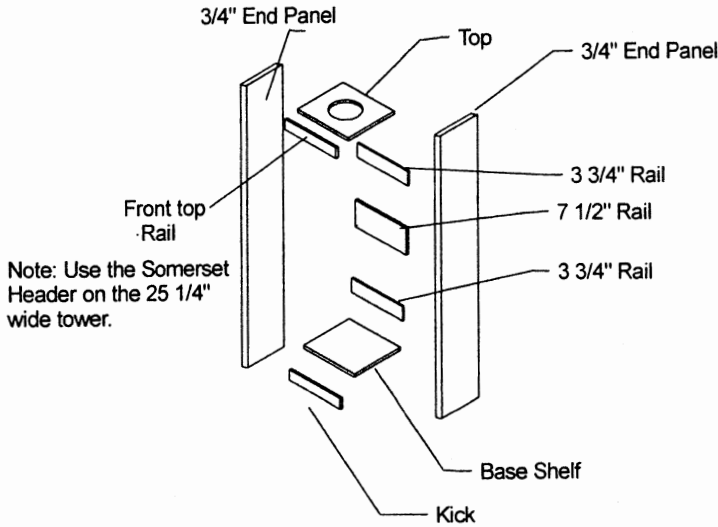

The Universal Black Plastic Connectors are the devices that hold the display together. The male and female black plastic pieces fit together, while a metal Pin is hand pressed into the slot, locking the device together. Push the pins until about a Cm. sticks out of the Black Plastic Connector.

There are 2 towers in 3 sample tower carton. One tower will be 25 1/4" wide and in a box by itself. The 25 1/4" wide tower will be placed in the center of the display. The 25 1/4" wide tower will hold the Somerset Header, packed separately. You want to open the carton that has the label on it "OPEN FIRST HARDWARE ENCLOSED". This carton will have a hardware bag located inside a cardboard filler on top. It is also marked "HARDWARE ENCLOSED".

There are 2 - 18" towers that will hold 14 sample boards. The angled shelves for both are pack in the box with the header. There are right and left towers (see plan view).

The shelf with the 1" spacer on the bottom is the bottom shelf. Pair its top to it so the grooves are facing each other. You will need to slide the 1/4" dividers in before putting on the bottom rail. The bottom rail will need a spacer screwed to it. (SEE BOTTOM SECTION INSTRUCTIONS)

Build all seven towers and then lay out the towers by the plan view. Now lets build the 7 towers.

- 1) Place two of the end panels on the the floor making sure you have a pair. Get your hardware bag and open the bag with the metal pins. Stand both ends on its back edge so the front edge is facing up. Install the front top rail (4 7/8" wide) to the top front connectors. (See diagram below of for instructions on working the Universal Black Plastic Connectors) Lock the top front rail in with the metal pins on both ends.
NOTE : THE 25 1/4" WIDE TOWER WILL USE THE SOMERSET HEADER FOR THE FRONT RAIL. THE HEADER IS PACKED IN A SEPARATE BOX MARKED "SOMERSET HEADER".
- 2) Install the top (has a 8" hole in it)by attaching it to the ends with the metal pins. (See diagram below of for instructions on working the Universal Black Plastic Connectors). Lock the top in with the metal pins on both ends.
- 3) Install the base shelf at the bottom of the tower ends. Make sure the edge band faces the front. Lock the base shelf to the ends using the metal pins.
- 4) Locate the kick plate (3" wide) and install under the base shelf. Simply snap it on aligning the brown plastic hardware on the kick to the brown tabs installed on the ends.
- 5) Lift the unit up so it stands upright. Install the back rail (3 3/4" wide) into the black plastic connectors located under the top in the back. Lock it in with the metal pins.
- 6) Install the middle back rail (7 1/2" wide with 4 back plastic connectors) in the middle of the back of the tower. Lock it in with the metal pins. Note: Some will have 4 - 3 3/4" rails)
- 7) Install the back rail (3 3/4" wide) into the black plastic connectors located above the base shelf in the back. Lock it in with the metal pins.
- 8) Make sure all metal pins are locked in.
- 9) Repeat these instructions for the other towers.
- 10) After building the 7 towers, look at the plan view to see how to lay out the display.
- 11) Read the instructions and use the diagram for installing fillers and cover panels.

!!!Screw towers together where noted on plan view !!!
DO NOT LEAVE LOOSE!!!!

If there are any questions, Please call Oliver Ross & Associates at: (804) 230 - 7280 or fax (804)595-0177

2017 SOMERSET SQUARE TOD LAYOUT

TOP VIEW

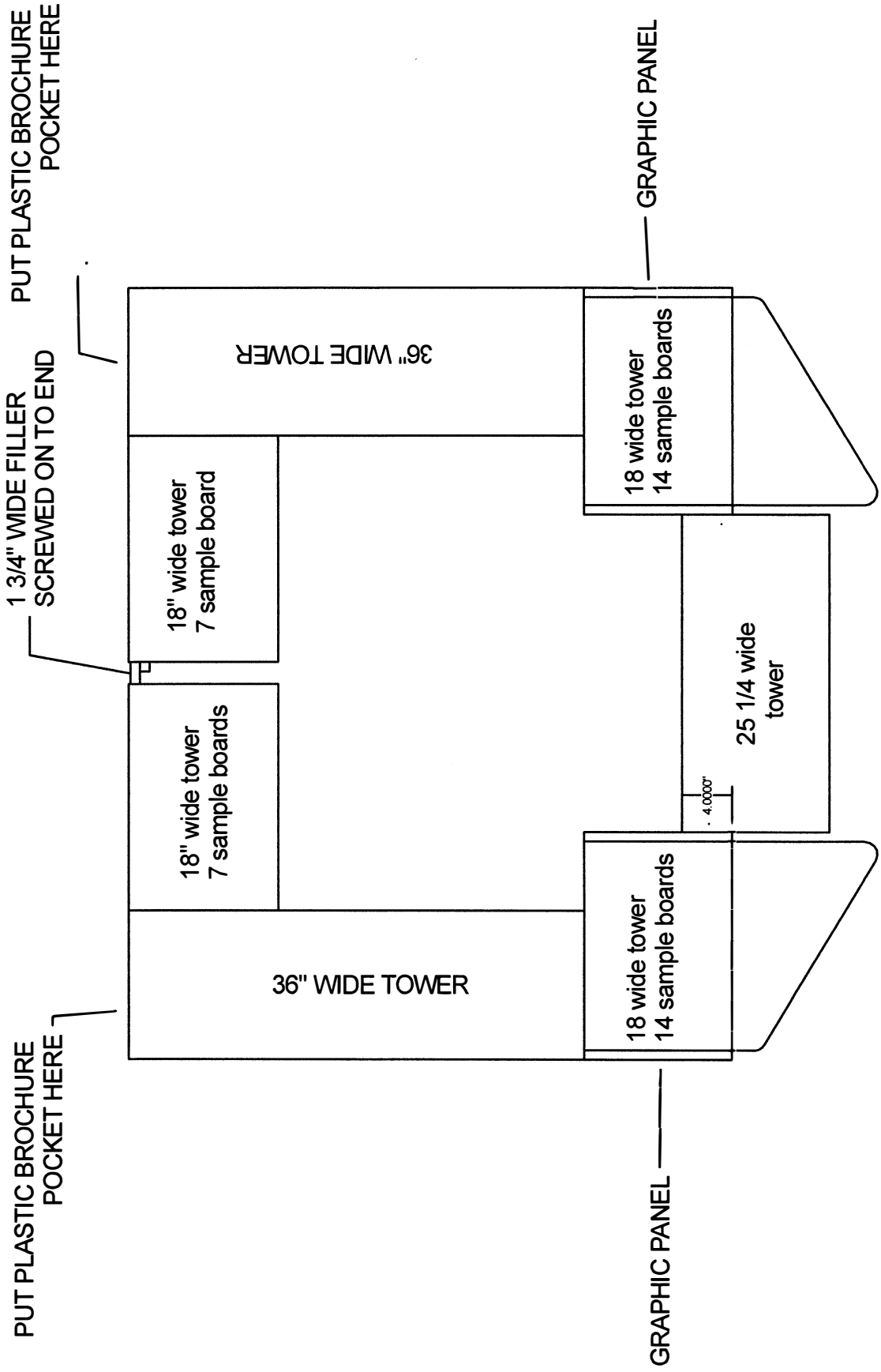

SCREW ALL TOWERS TOGETHER

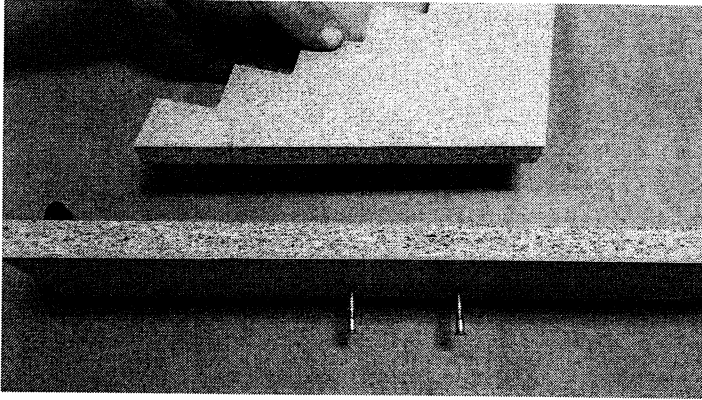

- 1) In the 18" wide 14 sample board box find the 2 - 18" back rail with 2 holes, 2 - step blocks and 2 confirmat screws(in hardware bag). Make 1 left hand and 1 right hand (Left hand shown). Screw the 2 pcs together.

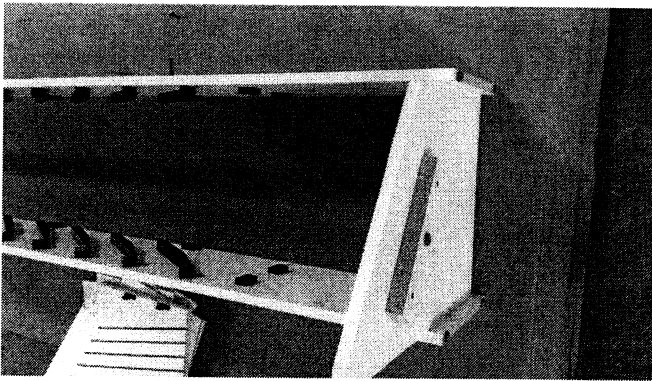

- 2) Locate angled bottom. Note: it has the 1" build up on bottom side. Install bottom to ends with metal pins.

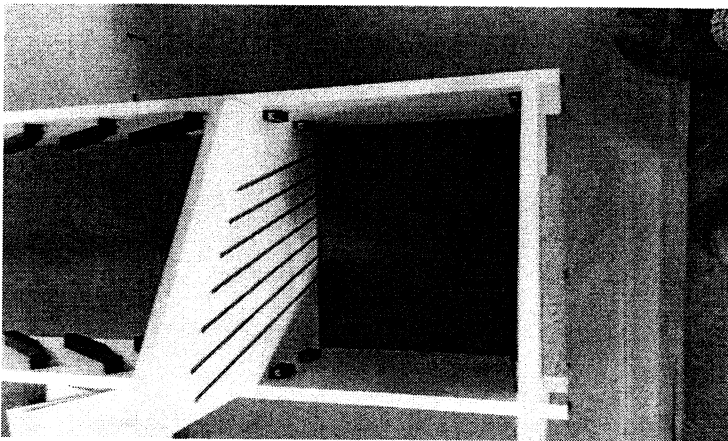

- 3) Install angled top shelf. Grooves should face down and match grooves on bottom. Lock in with metal pins.

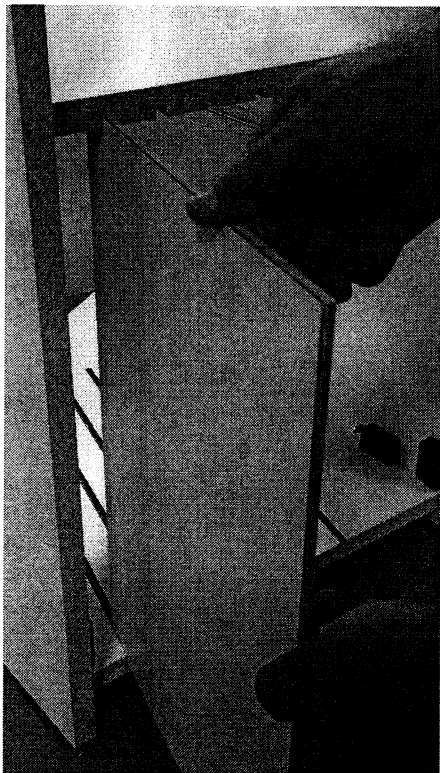

4) Stand unit up and slide the 7 - 1/4" dividers in all the way to the front.



5) Install the rail with the step block to the back of the ends and lock it with the metal pins. Complete the rest of the tower by installing the rails, top and front top rail. REMEMBER TO MAKE ONE LEFT HAND AND 1 RIGHT HAND. THE POINT ON THE ANGLED BOTTOM AND SHELF ARE TO THE OUT SIDE.

ATTACHING YOUR TOD COLLECTION HEADERS

Your new Collection Headers are backed with a removable self-adhesive. You'll find the appropriate Collection Header packed in the carton with the set of sample boards for each "bay."

IT'S EASY TO APPLY:

- 1) Simply remove the release liner on the back of the header.
- 2) Center the header over the collection "bay" on the main top header of your display, and stick in place. The header should sit just above the piece of trim molding at the bottom of the header.

Note: If you are updating a TOD, you will place the headers over the Collection type that is printed on your existing display, to cover it up.

- 3) **IMPORTANT:** Be sure to press firmly and rub several times back and forth all the way across the header to get a good adhesion.



1)

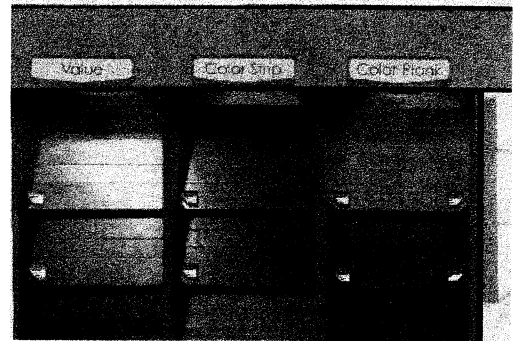

2)

The adhesive is a special removable type—so if further updates are needed in the future, removing the header will not harm your display. We don't recommend removing and reapplying often, as this can weaken the bond of the adhesive.

If you have any questions, please contact Somerset Hardwood Flooring at 1-877-404-9663. These instructions and more can be found at somersefloors.com. Please visit the Resource Center>For Dealers.

www.somersefloors.com



www.somersefloors.com